



# HotSpring<sup>®</sup>

*Every day made better<sup>®</sup>*

## ***HOT SPOT<sup>®</sup> COLLECTION***

**Congratulations on your decision to enjoy the finest spa available. Welcome to the growing family of Hot Spring Spa owners.**

# **Pre-Delivery Instructions**

Please take the time to read this booklet carefully, as it will provide you with the information you will need to ensure the safe, secure, and timely installation of your new spa. The following sections are guidelines on how to prepare for delivery and set-up of your new spa. Specifically covered are site selection, delivery access, ground preparation, and electrical requirements.

Remember to carefully read the Owner's Manual that accompanies your spa, and to complete the warranty registration within 10 days of delivery. These items, along with other valuable information, will be found in the Owner's Package which has been placed in the equipment compartment of your spa, where you will also find its serial number.

Watkins Wellness™ reserves the right to change features, specifications and design without notification and without incurring any obligation.

DATE PURCHASED: \_\_\_\_\_

Register your warranty  
using the QR code below:

DATE INSTALLED: \_\_\_\_\_

DEALER: \_\_\_\_\_

ADDRESS: \_\_\_\_\_

TELEPHONE: \_\_\_\_\_



In most cities and counties, permits will be required for the installation of electrical circuits or the construction of exterior surfaces (decks and gazebos). In addition, some communities have adopted residential barrier codes which may require fencing and/or self-closing gates on the property to prevent unsupervised access to a pool (or spa) by children under 5 years of age. Your Hot Spring spa is equipped with a locking cover that meets the ASTM F1346-91 Standard for Safety Covers and as a result, is usually exempt from most barrier requirements. As a general practice, your local Building Department will inform you of any applicable barrier requirements at the time a permit is obtained for the installation of an electrical circuit. Your Hot Spring dealer can provide information on which permits may be required.

# SITE SELECTION AND PREPARATION

**IMPORTANT:** Site selection and preparation are your responsibility. Carefully read these instructions and consult your authorized Hot Spring® dealer if you have any questions.

You probably have a spot picked out for your new spa, whether it's indoors or outdoors, on a patio or on a deck. Just make sure you check the following:

- Always put your spa on a structurally sound, level surface. A filled spa can weigh a great deal. Make certain that the location you choose can support the weight of your filled spa.
- Locate your spa away from any reflective surface or glass. The heat generated by some types of double-pane windows and reflective surfaces can cause serious damage to the exterior of the spa, including the siding and cover.
- Locate your equipment compartment, which houses all of the electrical components, in a place where water will drain away from it. Allowing water into the equipment compartment can damage the electronics, or may result in tripping your house's circuit breaker.
- Leave yourself easy access to the circuit breaker in the subpanel (when connected to 230 volts), or to the interrupter switch by the end of the power cord (115 volt models).
- Never let water get into the subpanel (when connected to 230 volts), into the interrupter switch (115 volt models), or into the electrical outlet that your spa is plugged into.
- Leave access to the entire front of the spa (the removable panels provide access to the spa's equipment) for periodic spa care and maintenance.

## OUTDOOR AND PATIO INSTALLATION

No matter where you install your new spa, it's important that you have a solid foundation to support it. Structural damage to the spa resulting from incorrect installation or placement on an inadequate foundation is not covered under the spa's limited warranty.

## DECK INSTALLATION

To be certain your deck can support your spa, you must know the deck's maximum load capacity. **Consult a qualified building contractor or structural engineer before you place the spa on an elevated deck or indoors.** To find the weight of your spa, its contents and occupants, refer to the Spa Specification chart located toward the end of this document. This weight per square foot must not exceed the structure's rated capacity, or serious structural damage could result.

## INDOOR INSTALLATION

Be aware of some special requirements if you place your spa indoors. Water will accumulate around the spa, so flooring materials must provide a good grip when wet. Proper drainage is essential to prevent a build-up of water around the spa. When building a new room for the spa, it is recommended that a floor drain be installed. The humidity will naturally increase with the spa installed. Water may get into woodwork and produce dry rot, mildew, or other problems. Check for airborne moisture's effects on exposed wood, paper, etc. in the room. To minimize these effects, it is best to provide plenty of ventilation to the spa area. An architect can help to determine if more ventilation must be installed.

Your Hot Spot dealer can help you with local information such as zoning regulations and building codes.

# DELIVERY ACCESS

First, locate the dimensions of your spa on the following chart. The dimensions shown are the measurements of the spa in the vertical position, laid on its side.

Next, contact your dealer to find the height and width added by the delivery cart which the dealer will use to deliver your new spa. Use the height of the cart plus the dimension shown as H to determine the vertical clearance required to pass the spa and cart. Use the width of the cart, or dimension W, whichever is greater, to determine the maximum width of clearance necessary. Use the length dimension L when making any sharp turns to determine the maximum clearance required.

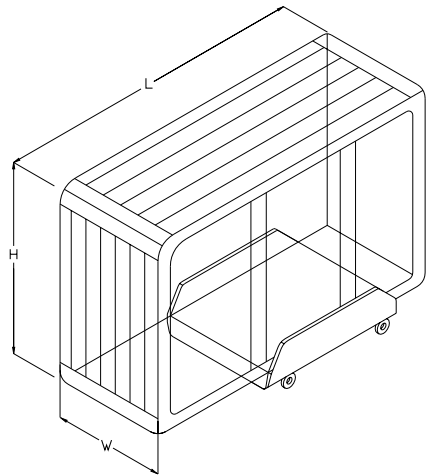

**NOTE:** It may be necessary to allow for additional overhead clearance if the spa will be rolled up or down an incline or moved up or down a short flight of stairs.

Use the information below to determine the requirements for access to your desired location.

It may be necessary to remove a gate, part of a fence, or other movable obstructions in order to roll the spa to its installation site.

Model	Width W	Length L	Height H
Relay® (REL)	36" (92 cm)	84" (2.13 m)	84" (2.13 m)
Rhythm® (RHY)	36" (92 cm)	84" (2.13 m)	84" (2.13 m)
Pace™ (PAC)	33" (84 cm)	82" (2.08 m)	82" (2.08 m)
Stride® (STD)	29" (74 cm)	84" (2.13 m)	65" (1.65 m)
SX (SX)	33" (84 cm)	77" (1.96 m)	72" (1.83 m)
TX (TX)	29" (74 cm)	72" (1.83 m)	72" (1.83 m)

How is your width clearance?

Check all gates

Protruding electric meters  
Gas meters  
A/C units

Do you have sufficient overhead clearance?

Check low roof eaves,  
overhanging branches,  
rain gutters

Is the path clear?

Move away branches, dog  
houses, firewood, etc.

If there is a 90° turn, can we  
clear it? (The spa will not bend)

No more than 6 consecutive  
stairs without a landing

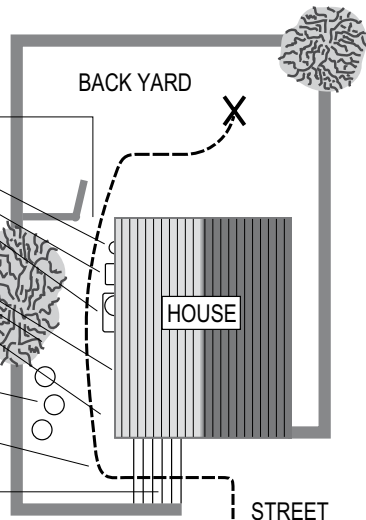

If the spa has to be taken off of the cart to go over a wall (either because the entry area is too narrow, the eaves are too low, the corner is too tight, or the stairway is too steep), a crane will be required. Don't be alarmed! About ten percent of the time, a crane is the only way to install the spa by lifting it to its final destination.

The crane has a truck-mounted boom which can fit right in your driveway. It is run by a licensed and insured operator. For a charge, the crane operator will lift your spa over walls, buildings, or any other obstruction and place it as close to the installation site as possible. The Hot Spring® spa delivery personnel will supervise the crane delivery and complete the spa installation.

**NOTE:** If your spa delivery requires the use of a crane, you may be required to pay for its services at the completion of the delivery.

## GROUND PREPARATION

Your Hot Spring spa has been engineered to perform on all kinds of common yard surfaces. While a concrete slab is best for long-term use\*, other foundations are acceptable so long as a level base is prepared prior to delivery.

**\*NOTE:** Have a reinforced concrete pad at least 4 inches (10cm) thick or a deck that is able to withstand the pounds per square foot listed in the Spa Specification section.

### INSTALLATION NOTES:

- Concrete sloped at 1/2 inch per 10 feet (1 cm per 3 m) is preferred so that rain water and water spillover will run off and not puddle underneath the spa (water under the spa for long periods of time may cause the wood to deteriorate).
- If brick or wood decking is selected for the spa foundation, it should be placed and leveled below the entire spa to maintain even distribution of the spa weight.
- It is important to note that if bricks are used to distribute the weight of the spa there may still be a tendency to settle unevenly, resulting in an unlevel spa.
- Remember, placing the spa around grass or dirt may increase the amount of debris which is inadvertently brought into the spa water on the user's feet.

If you are purchasing a deck package or a gazebo with your spa, a solid foundation becomes mandatory. Placing them on any surface other than a single level pad could create problems with their installation. Pictured at right are a few of the recommended surfaces.

As a homeowner, it is your responsibility to provide a suitable, level foundation for your spa. Keep in mind that most delivery crews are not equipped to level and prepare spa sites.

If you are interested in having a concrete slab, brick surface, or wood deck installed, your Hot Spring dealer should be able to suggest a qualified, licensed contractor.

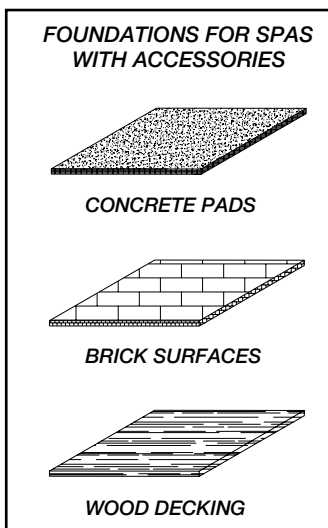

# RELAY® / RHYTHM® (Model REL/RHY)

## Dimensions

**NOTE:** All dimensions are approximate; measure your spa before making critical design or pathway decisions. Configuration and location may change without notice.

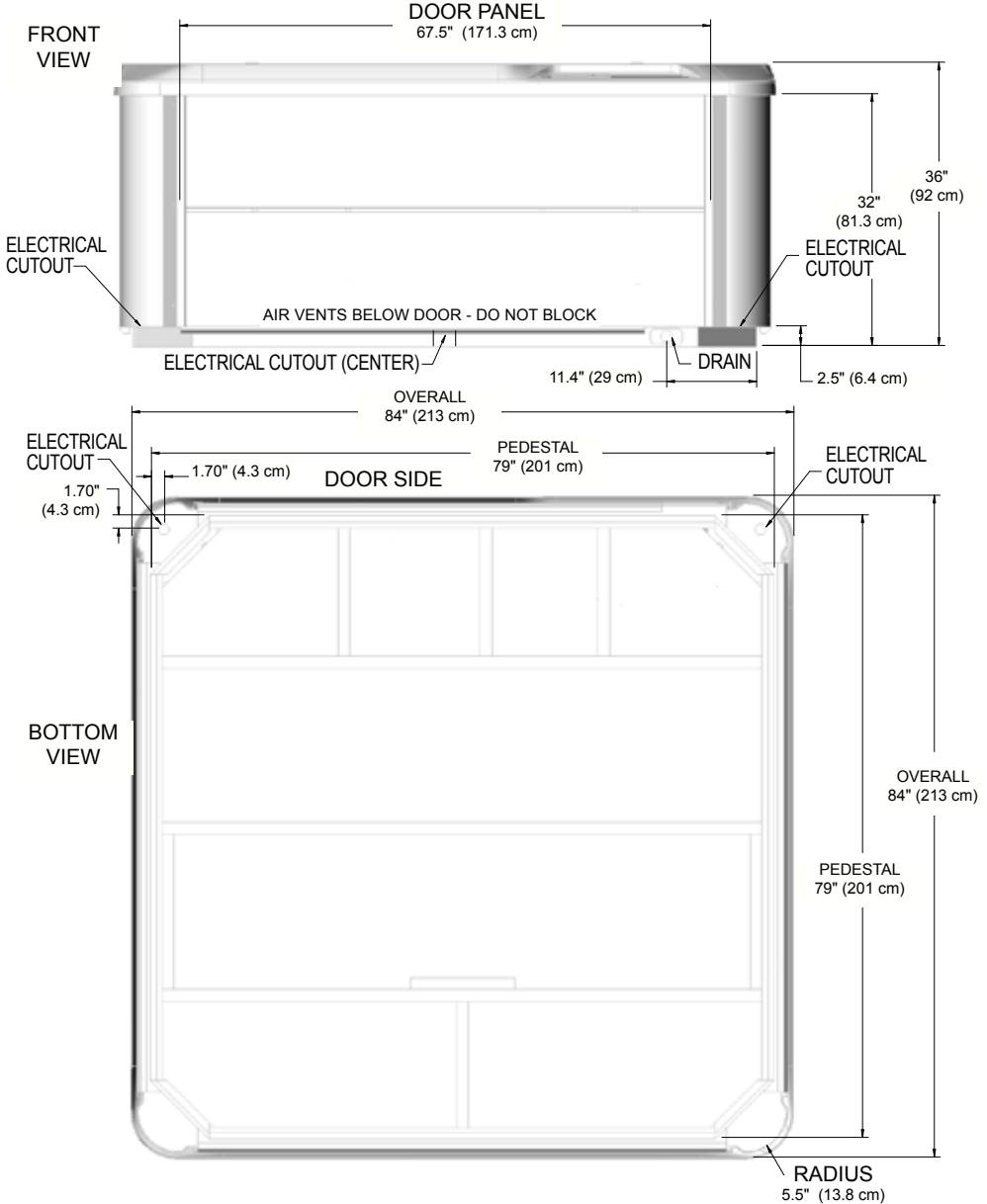

**NOTE:** WATKINS WELLNESS recommends that the Relay & Rhythm be installed on a minimum 4" (10.2 cm) thick reinforced concrete pad or structurally sound deck able to support the "dead weight" found in the spa specification chart.

**IMPORTANT:** THE RELAY & RHYTHM MUST NOT BE SHIMMED IN ANY MANNER.

# PACE™ (Model PAC)

## Dimensions

**NOTE:** All dimensions are approximate; measure your spa before making critical design or pathway decisions. Configuration and location may change without notice.

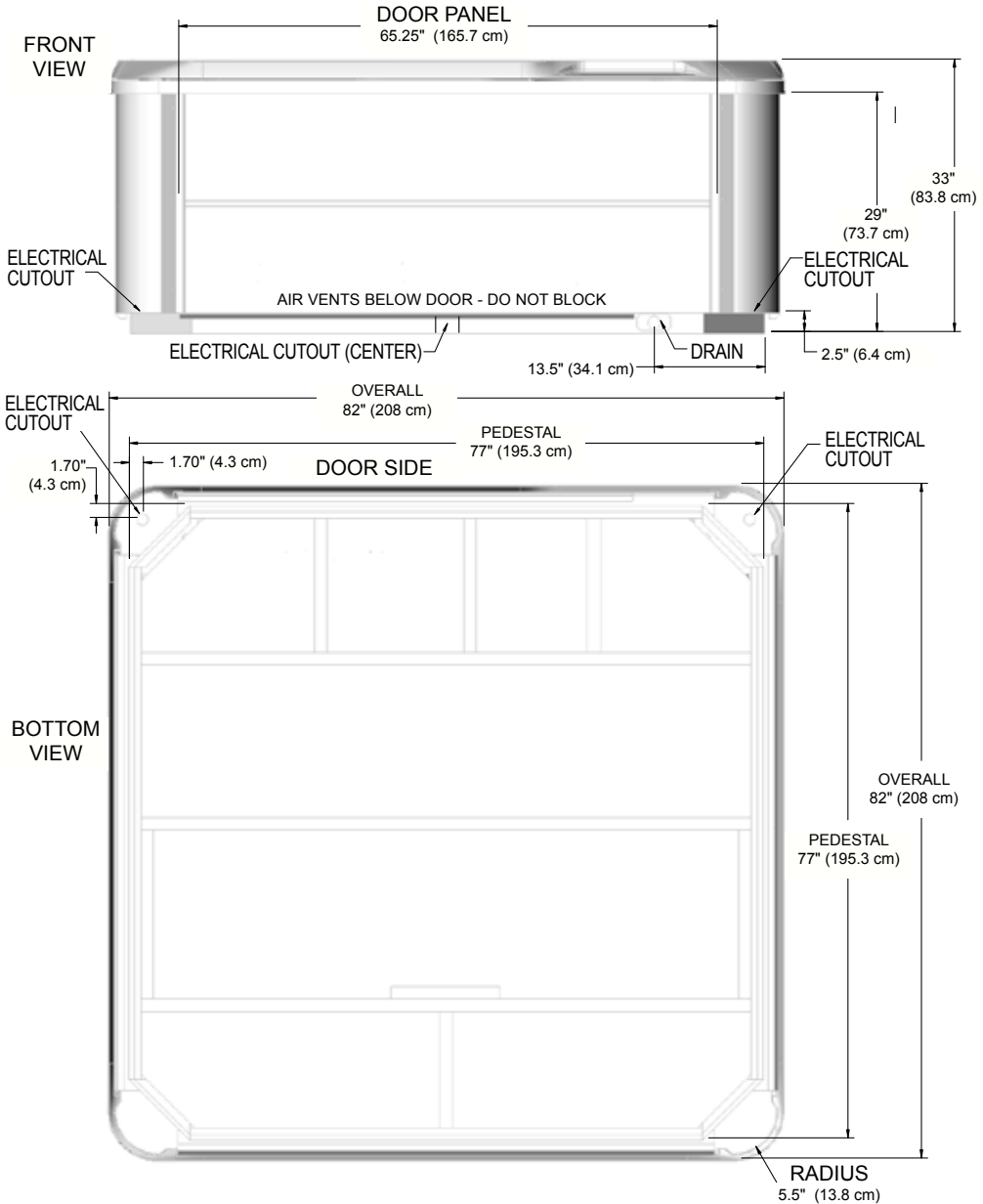

**NOTE:** WATKINS WELLNESS recommends that the PACE be installed on a minimum 4" (10.2 cm) thick reinforced concrete pad or structurally sound deck able to support the "dead weight" found in the spa specification chart.

**IMPORTANT:** THE PACE MUST NOT BE SHIMMED IN ANY MANNER.

# STRIDE® (Model STD)

## Dimensions

**NOTE:** All dimensions are approximate; measure your spa before making critical design or pathway decisions. Configuration and location may change without notice.

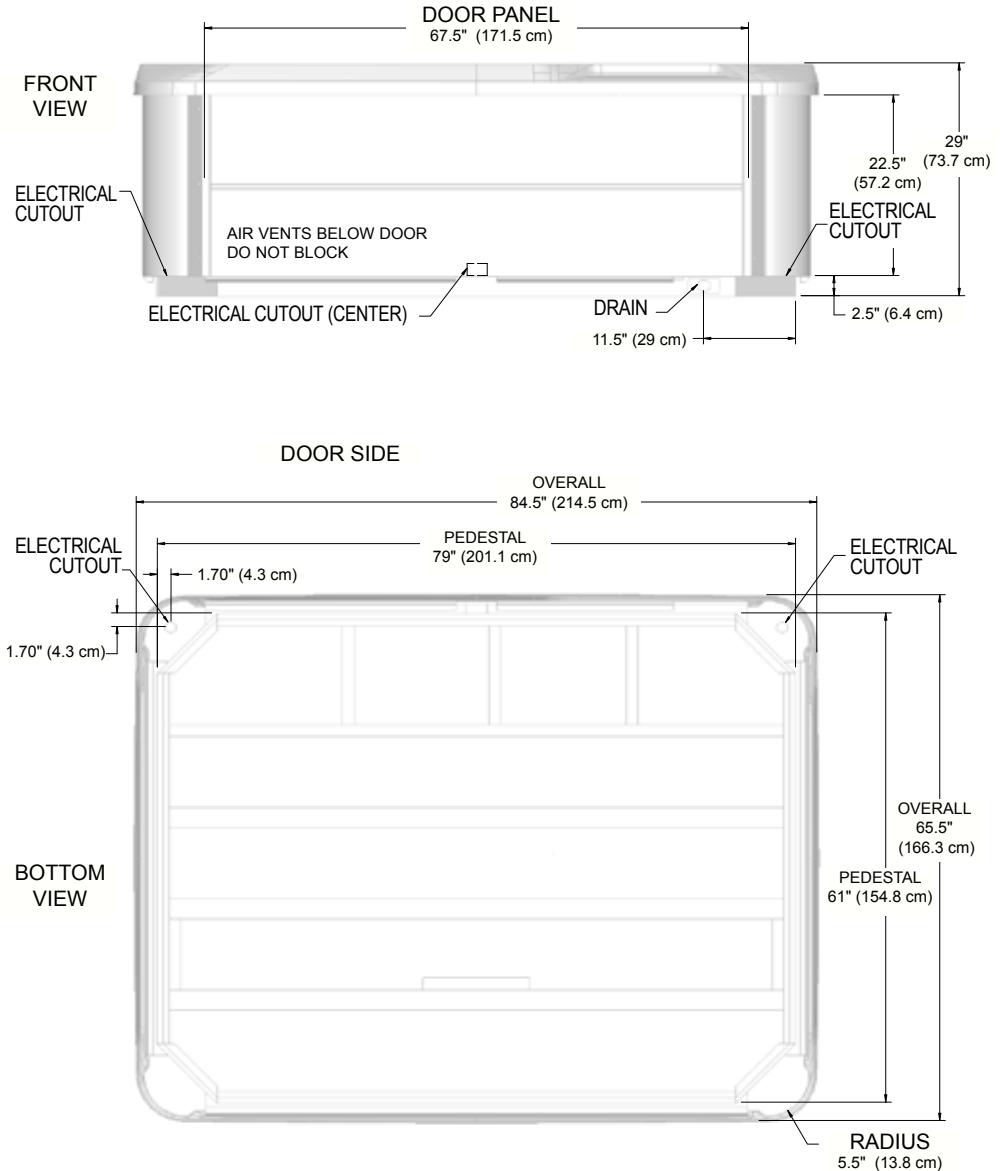

**NOTE:** WATKINS WELLNESS recommends that the STRIDE be installed on a minimum 4" (10.2 cm) thick reinforced concrete pad or structurally sound deck able to support the "dead weight" found in the spa specification chart.

**IMPORTANT:** THE STRIDE MUST NOT BE SHIMMED IN ANY MANNER.

# SX (Model SX)

## Dimensions

**NOTE:** All dimensions are approximate; measure your spa before making critical design or pathway decisions. Configuration and location may change without notice.

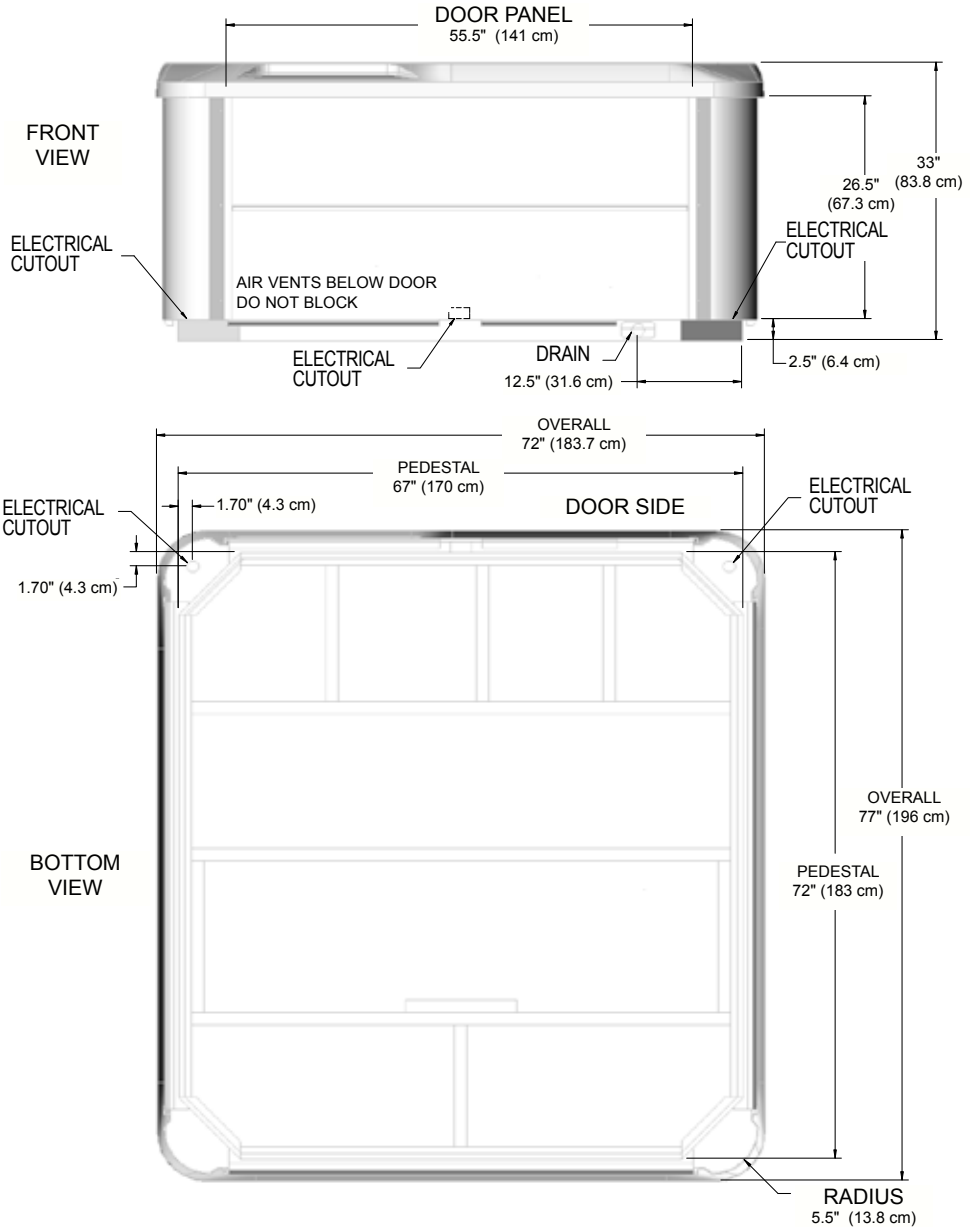

**NOTE:** WATKINS WELLNESS recommends that the SX be installed on a minimum 4" (10.2 cm) thick reinforced concrete pad or structurally sound deck able to support the "dead weight" found in the spa specification chart.

**IMPORTANT:** THE SX MUST NOT BE SHIMMED IN ANY MANNER.



# TX (Model TX)

## Dimensions

**NOTE:** All dimensions are approximate; measure your spa before making critical design or pathway decisions. Configuration and location may change without notice.

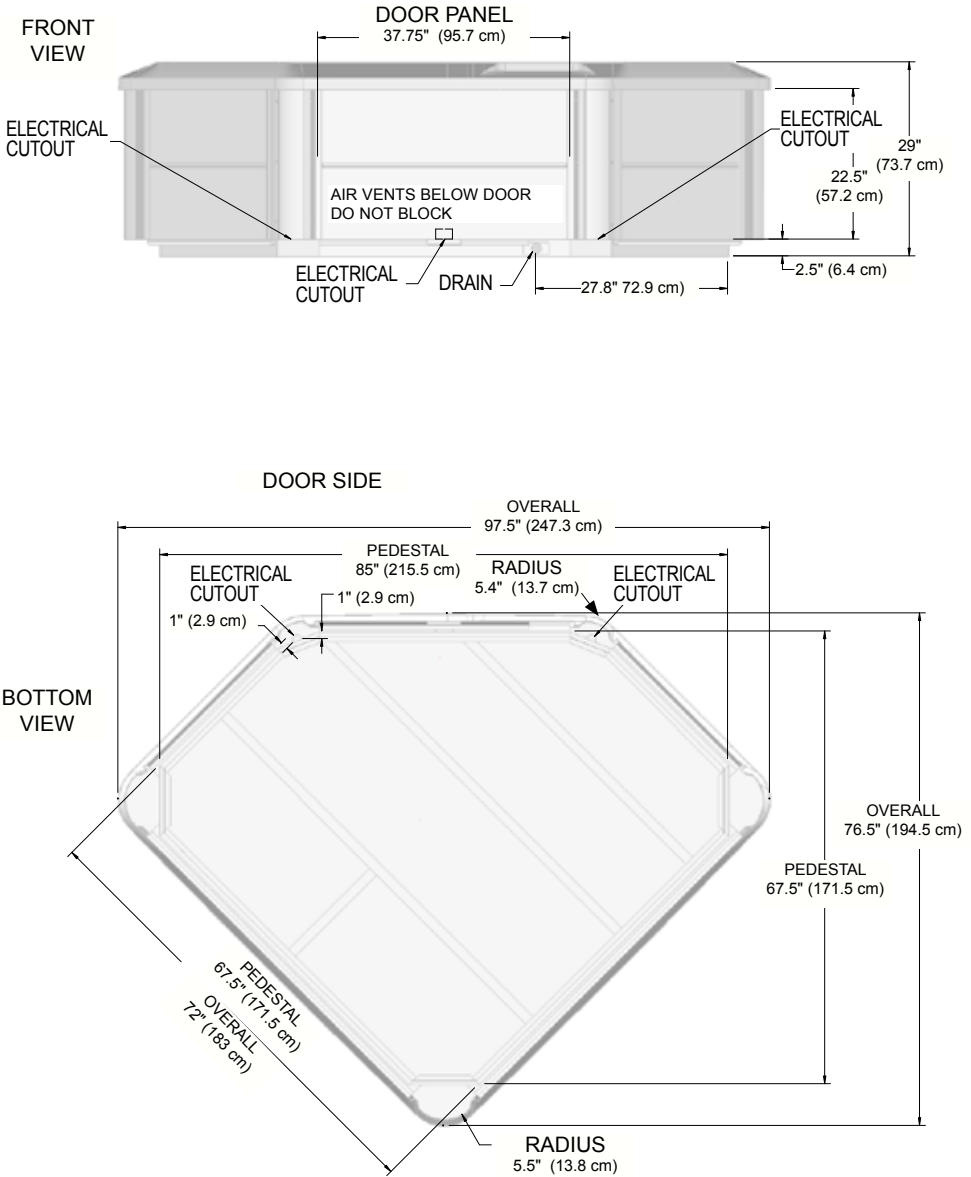

**NOTE:** WATKINS WELLNESS recommends that the TX be installed on a minimum 4" (10.2 cm) thick reinforced concrete pad or structurally sound deck able to support the "dead weight" found in the spa specification chart.

**IMPORTANT:** THE TX MUST NOT BE SHIMMED IN ANY MANNER.

# ELECTRICAL REQUIREMENTS

## SELECTING THE VOLTAGE FOR YOUR SPA

The Pace™, Stride™, SX and TX operates on 115 volts 20 amp (15 amp for TX) 60 Hz. These models can also be converted to either 115 volt 30 amp or 230 volt 50 amp. The Relay® and Rhythm® models require a dedicated 230 volt power supply. When the Pace, Stride, SX or TX is connected to 115 volts 15 or 20 amp, the heater will provide approximately 1000 watts of heat only when the pump is operating in LOW speed and the thermostat is calling for heat. When the Pace, Stride, SX or TX spa is connected to 115 volts 30 amp, the heater will provide approximately 1000 watts of heat when the pump is operating in LOW or HIGH speed and the thermostat is calling for heat. When the Pace, Stride, SX or TX is connected to 230 volts 50 amps, the heater will provide approximately 4000 watts of heat when the pump is operating in LOW or HIGH speed and the thermostat is calling for heat.

All electrical connections must be made in accordance with the wiring information contained in the electrical control box or on the back of the field wiring access panel of the equipment module.

## STANDARD, CORD-CONNECTED 115 VOLT 15 OR 20 AMP CONFIGURATION

For your safety, if you are having an electrician install an electric outlet for the spa it should be no closer than 5 feet (1.5 m) and no further than 10 feet (3 m) from the spa. [Reference National Electrical Code 680 - 6a(1) and 680 - 41a.]

One GFCI is used in the cord-connected 20 amp configuration. The GFCI module is located at the end of the power cord. To test the GFCI, simply press the TEST button. The GFCI should trip to the “off” position, disconnecting power to the spa. To reset the GFCI, press the RESET button. The GFCI should reset, and power should be restored to the spa. If the GFCI does not function in this way, unplug the cord and contact an authorized Hot Spring spa service technician.

**NOTE:** Consult your local code authority to determine if an electrical outlet with a cover is required for your installation. If it is, a suitable outlet cover may be purchased from your authorized Hot Spot dealer.

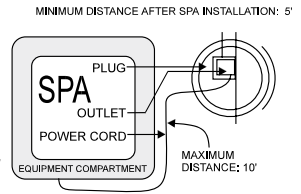

## 115 VOLT 20 AMP ELECTRICAL REQUIREMENTS

The Pace, Stride and SX spa models must be connected to a 115 volt, 20 amp grounded circuit. A dedicated circuit is required; the term “dedicated” means the electrical circuit is not being used for any other high-load electrical items (patio lights, appliances, garage circuits, etc.). If the spa is connected to a non-dedicated circuit, overloading will result in “nuisance tripping” of the internal fuses or of the breaker switch at the house electrical breaker panel.

The circuit must be properly wired; that is, it must have the following:

- Standard (cord-connected) 115 volt 20 amp (Pace, Stride & SX models) – A minimum 20 amp GFCI circuit breaker in the house panel, #12 AWG or larger wire (including the ground wire) and the correct polarity throughout the circuit.

In addition to the dedicated 20 amp, 115 volt GFCI protected circuit, your spa requires a 20 amp single receptacle. This receptacle, which contains an outdoor-rated, weather-resistant receptacle cover plate, will be provided to you. The single receptacle and cover plate should be installed by your electrician prior to the delivery of your spa.

A pressure wire connector is provided on the exterior surface of the spa's electrical control box, located inside the equipment compartment. This is to permit the connection of a bonding ground wire between this point and any metal equipment, enclosures, pipe or conduit within five feet of the spa (if needed to comply with local building code requirements). The bonding wire must be at least a #8 AWG copper wire.

### NEVER CONNECT THE SPA TO AN EXTENSION CORD!

Each Pace, Stride, SX and TX spa comes equipped with approximately 15 feet (4.5 m) of usable power cord (this is the maximum length allowed by regulatory standards and the National Electric Code). The power cord is stored for shipping inside the spa. To remove the power cord, open the equipment compartment and locate the cord. Carefully pull the cord out of the equipment compartment to the desired length and place in center cutout .

**NOTE:** Canadian regulations prevent Pace™, Stride and SX spas to come with a power cord and are require to be wired directly to the power source. Use Canadian Electrical Codes for electrical installation.

## 115 VOLT 30 AMP CONVERSION (PACE, STRIDE, SX & TX SPAS)

To ensure you will have an opportunity to use your spa soon after delivery, it is very important that the required electrical service has been installed. Unless otherwise stipulated by your dealer, **THIS IS YOUR RESPONSIBILITY.**

**IMPORTANT:** All electrical circuits must be installed by a qualified, licensed electrician.

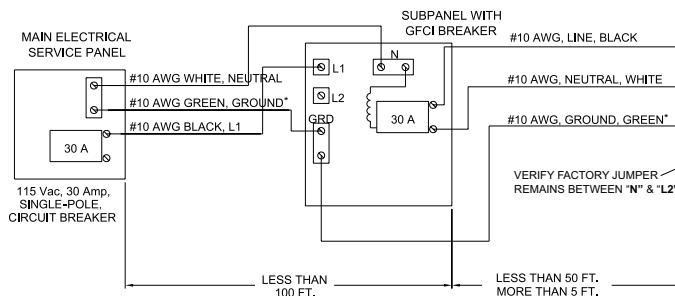

See  
Owner's Manual  
for Spa Wiring  
and Jumper  
Configuration

## 230 VOLT INSTALLATION (RELAY® & RHYTHM® AND OPTIONAL PACE, STRIDE, SX AND TX CONVERTED SPA MODEL)

Your spa contains a control box designed to operate at 230V, 60Hz. Installation of a 50 amp. dedicated circuit is required for Relay & Rhythm spas and optional for the other spa models. The control box must be hard wired directly to a subpanel protected by a Ground Fault Circuit Interrupter (GFCI). The subpanel containing GFCI breakers is included with the Relay & Rhythm spa models only. Purchase the subpanel from your dealer for the converted models when converting to 230 volts.

**IMPORTANT NOTE:** All electrical connections to the control box must be accomplished by a qualified electrician in accordance with the National Electrical Code and in accordance with any local electrical codes in effect at the time and place of installation.

All electrical connections must be made in accordance with the wiring information contained in this manual and on the back of the field wiring access panel of the control box. A licensed electrician should install a four-wire electrical service (two line voltages, one neutral, one ground) from the main electrical service panel to the subpanel.

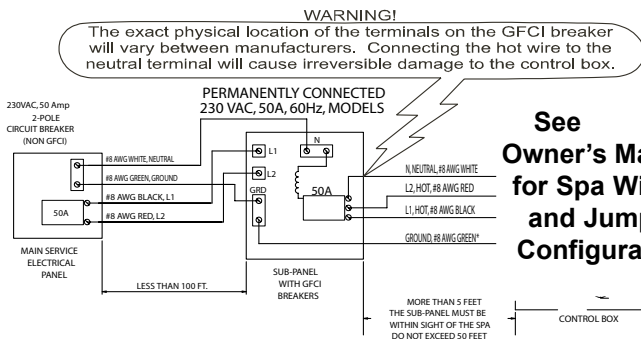

See  
Owner's Manual  
for Spa Wiring  
and Jumper  
Configuration

Your electrician should mount the subpanel in the vicinity of the spa but it should not be closer than five feet (1.5 m) from the spa water edge (NEC 680-38 to 41-A-3).

**INSTALLATION NOTE:** After the spa has been installed, your electrician can connect the conduit from the subpanel to the spa's control box and then complete the wiring connections in the control box. **NOTE:** Complete step-by-step Installation and Wiring Instructions for all models are included in the Owner's Manual.

**WARNING:** Removing or bypassing the GFCI breakers in the subpanel at any time will result in an unsafe spa and will void the warranty.

# How to Install Power Wires into TB

**NOTE:** Install Ground into single lug below terminal block

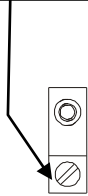
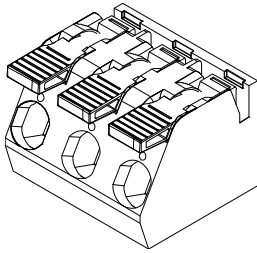

<p>1.</p> <p>Strip wire insulation back 1/2" (12.5 mm)</p>	<p>2.</p> <p>Open Terminal Block by lifting lever to the UP position</p>
<p>3.</p> <p>Insert wire fully into Terminal Block</p>	<p>4.</p> <p>Close Terminal Block by lowering lever to the DOWN position <b>IMPORTANT:</b> Lever must be in the FULL DOWN position to Lock wire</p>
<p>5.</p> <p>Repeat steps 1-4 to add additional wires.</p>	

# SPA SPECIFICATIONS

## CONTRACTOR SUGGESTIONS

### *Electrician*

Name: \_\_\_\_\_

Telephone: \_\_\_\_\_

Name: \_\_\_\_\_

Telephone: \_\_\_\_\_

### *General*

Name: \_\_\_\_\_

Telephone: \_\_\_\_\_

Name: \_\_\_\_\_

Telephone: \_\_\_\_\_

## ***ADDITIONAL PRODUCTS AVAILABLE FROM YOUR HOT SPRING® SPA DEALER***

- FreshWater® water care products
- Spa Frog® @ease products
- Vanishing Act® Calcium Remover
- Clean Screen® Pre-Filter
- Spa vacuums
- Spa upgrade jet kits
- Replacement filter cartridges
- Pillows
- Spa Steps

Retractable cover system with clearance requirements (Available for all models except TX)

- Cover Cradle® – 24" (61 cm) Clearance required
- Cover Cradle II – 24" (61 cm) Clearance required
- UpRite® – 7" (18 cm) Clearance required

# SERVICES AVAILABLE FROM YOUR HOT SPRING® SPA DEALER

<i>Service</i>	<i>Cost</i>
Pre-Delivery site inspection	_____
Deliver spa to installation site	_____
Unwrap spa and haul away packaging material	_____
Set up spa	_____
Fill the spa with water	_____
Connect the spa to its power source (115 Volt 15/20 amp models)	_____
Explain and test the spa's operation	
• Jet system	
• Air Control system	
• Set temperature control	
• Control panel functions	
Explain the safety features	
• GFCI	
• Heater high limit	
General spa operation & maintenance orientation	_____
Water quality and maintenance orientation	_____
Adjust the water's Total Alkalinity, and pH	_____
Sanitize the water	_____
Inspect the spa cover, place on spa and install cover locks	_____
Review Owner's Manual & Warranty Card	_____
Follow-up call	_____
In-store spa water analysis	_____
<b>TOTAL COST</b>	_____

# Spa Specifications

	Footprint dimensions	Height	Effective filter area	Heater (Watts)	Water capacity	Dry weight	Filled weight*	Dead weight*	Electrical requirements
Relay® (REL) Seating (6 Adults)	84"x 84" 2.13m x 2.13m	36" 92 cm	65 ft²	4,000	340 Gallons 1,290 litres	830 lbs 375 kg	4,715 lbs 2,140 kg	120 lbs/ft² 590 kg/m²	230 volt, 50 amp Single phase GFCI circuit
Rhythm® (RHY) Seating (7 Adults)	84"x 84" 2.13m x 2.13m	36" 92 cm	65 ft²	4,000	330 Gallons 1,250 litres	845 lbs 383 kg	4,820 lbs 2,185 kg	125 lbs/ft² 610 kg/m²	230 volt, 50 amp Single phase GFCI circuit
**Pace™ (PAC) Seating (5 Adults)	82"x 82" 2.08m x 2.08m	33" 84 cm	30 ft²	1,000 or 4,000 @ 230V	300 Gallons 1,135 litres	775 lbs 350 kg	4,150 lbs 1,880 kg	115 lbs/ft² 565 kg/m²	115 volt, 20 amp or 30 amp Dedicated GFCI or 230 volt, 50 amp Single phase GFCI circuit
**Stride® (STD) Seating (3 Adults)	84"x 65" 2.13m x 1.65m	29" 74 cm	30 ft²	1,000 or 4,000 @ 230V	225 Gallons 850 litres	570 lbs 260 kg	2,975 lbs 1,350 kg	100 lbs/ft² 490 kg/m²	115 volt, 20 amp or 30 amp Dedicated GFCI or 230 volt, 50 amp Single phase GFCI circuit
**SX (SX) Seating (3 Adults)	72"x 77" 1.83m x 1.96m	33" 84 cm	30 ft²	1,000 or 4,000 @ 230V	230 Gallons 870 litres	645 lbs 295 kg	3,090 lbs 1,400 kg	105 lbs/ft² 515 kg/m²	115 volt, 20 amp or 30 amp Dedicated GFCI or 230 volt, 50 amp Single phase GFCI circuit
**TX® (TX) Seating (2 Adults)	72"x 72" 1.83m x 1.83m	29" 74 cm	30 ft²	1,000 or 4,000 @ 230V	190 Gallons 720 litres	635 lbs 290 kg	2,570 lbs 1,165 kg	95 lbs/ft² 465 kg/m²	115 volt, 15 amp or 30 amp Dedicated GFCI or 230 volt, 50 amp Single phase GFCI circuit

**CAUTION: WATKINS WELLNESS** suggests a structural engineer or contractor be consulted before the spa is placed on an elevated deck.

\* **NOTE:** The "Filled weight" and "Dead weight" of the spa includes the weight of the max. occupants (assuming an average occupant weight of 175 lbs (80 kg)).

\*\* **NOTE:** This spa may also be converted to a 115 volt, 30 amp Single phase GFCI circuit

Please note: Due to our manufacturing processes, spa size tolerances or dimensions may vary by .5" or 1.25 cm.



# Watkins Wellness®

*Feel good. Live well.*

1280 Park Center Drive  
Vista, California 92081  
(800) 999-4688 extension 8432

©2020 WATKINS WELLNESS. Hot Spot, Hot Spring, Tempo, Relay, Rhythm, Stride, Cover Cradle, UpRite, Lift 'n Glide, EverFresh, FreshWater, Vanishing Act, Clean Screen and The Home Relaxation Specialists are trademarks of WATKINS WELLNESS.

62906.21 A (11/20)